

ADAPTER: PEEDI - 4x COP16 (PowerPC)

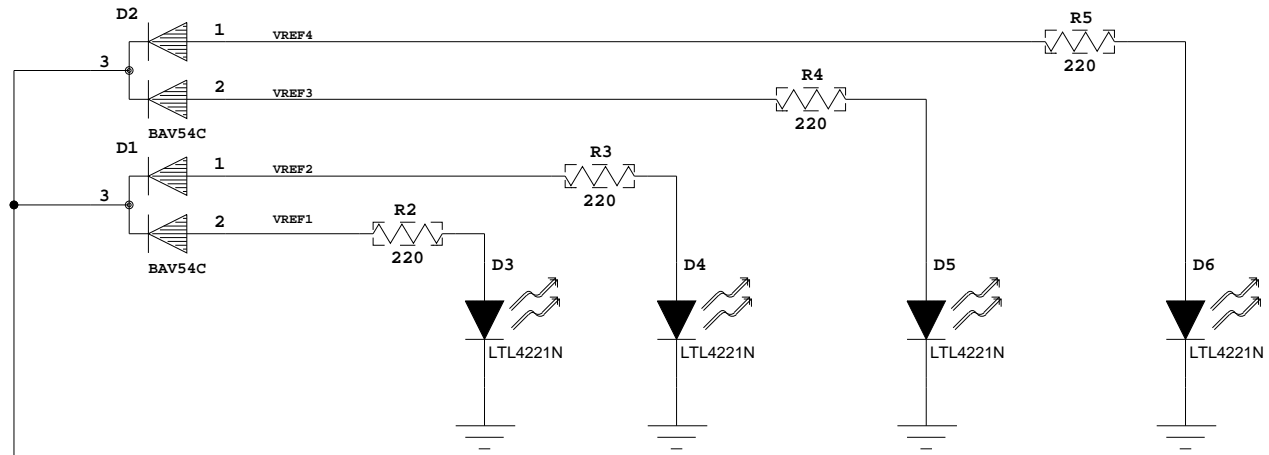

PEEDI

TARGET PowerPC

TARGET PowerPC

TARGET PowerPC

TARGET PowerPC

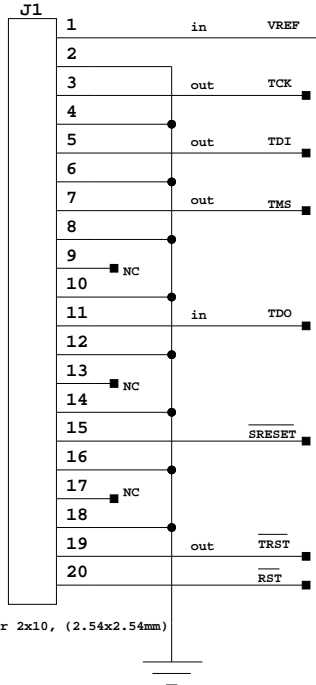

Header 2x10, (2.54x2.54mm)

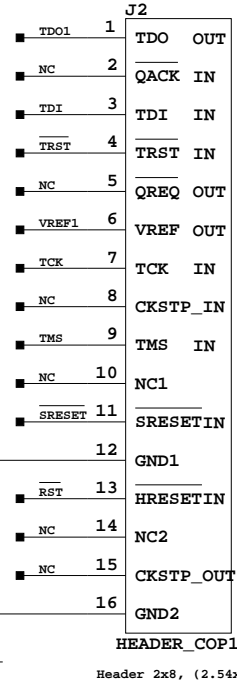

HEADER_COP16

Header 2x8, (2.54x2.54mm)

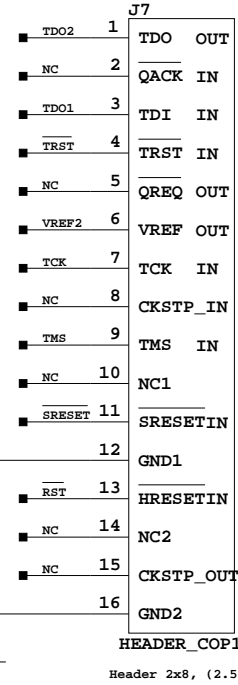

HEADER_COP16

Header 2x8, (2.54x2.54mm)

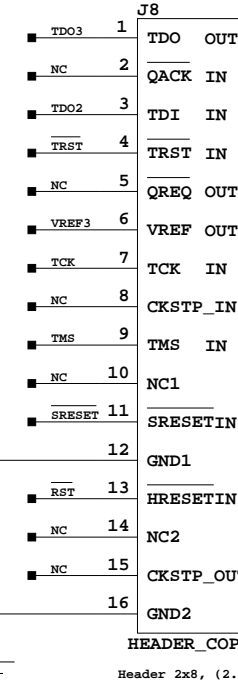

HEADER_COP16

Header 2x8, (2.54x2.54mm)

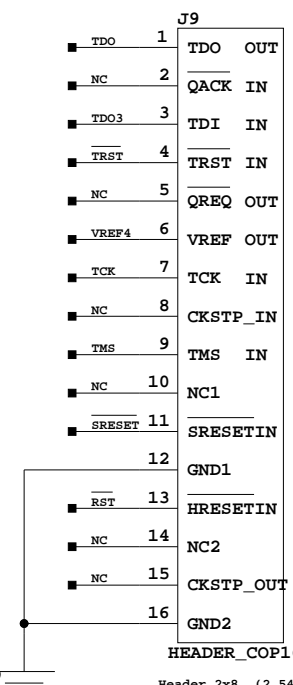

HEADER_COP16

Header 2x8, (2.54x2.54mm)

HOLE3_5MM HOLE3_5MM HOLE3_5MM HOLE3_5MM

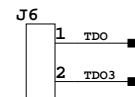
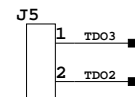
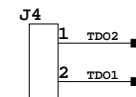
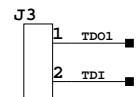
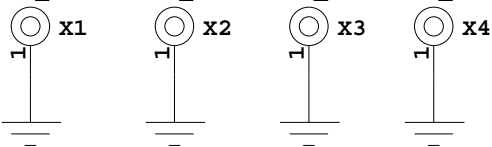

Title: PEEDI-4XCOP16	Module: ADAPTER		
Company: RONETIX GMBH	Size A4	Rev. 1.0	
Author: ILKO ILIEV	12-25-2009_12:53:11 Page 1 of 1		